



Вентилируемые
фасады
с применением
стальных решений
при реконструкции
зданий

www.pruszynski.com.ua







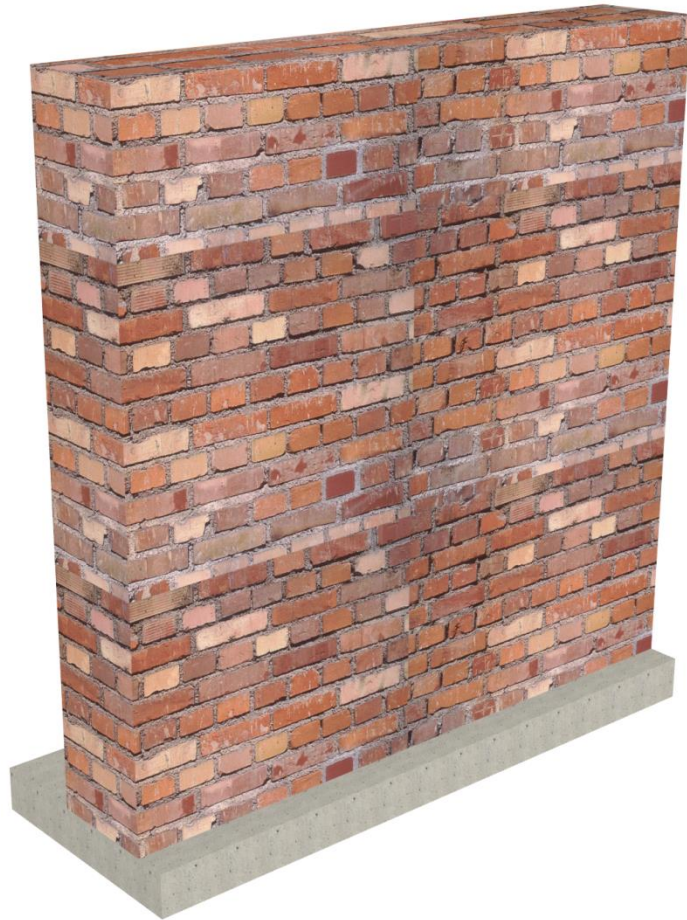

Уголок перфорированный усиленный

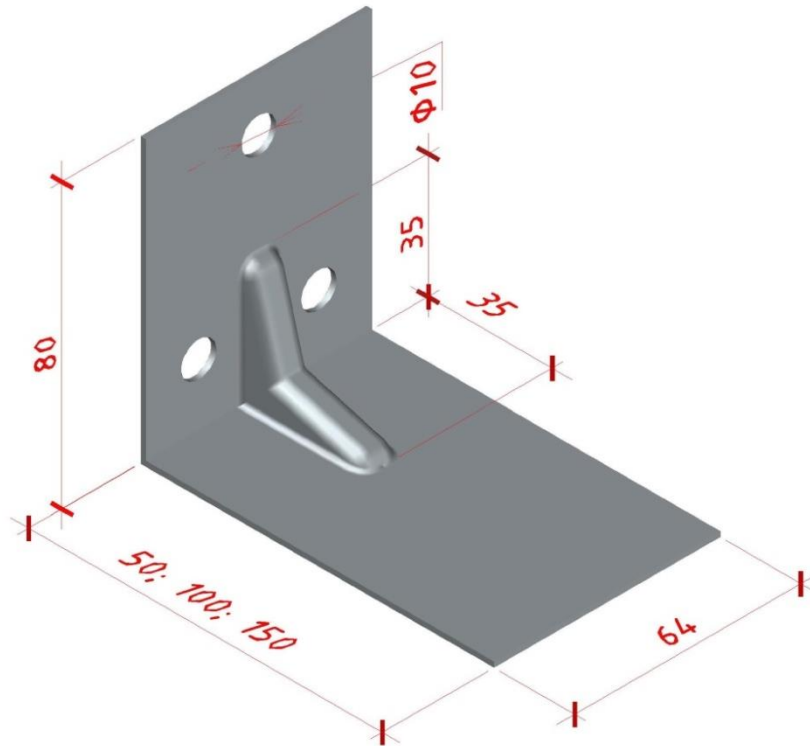

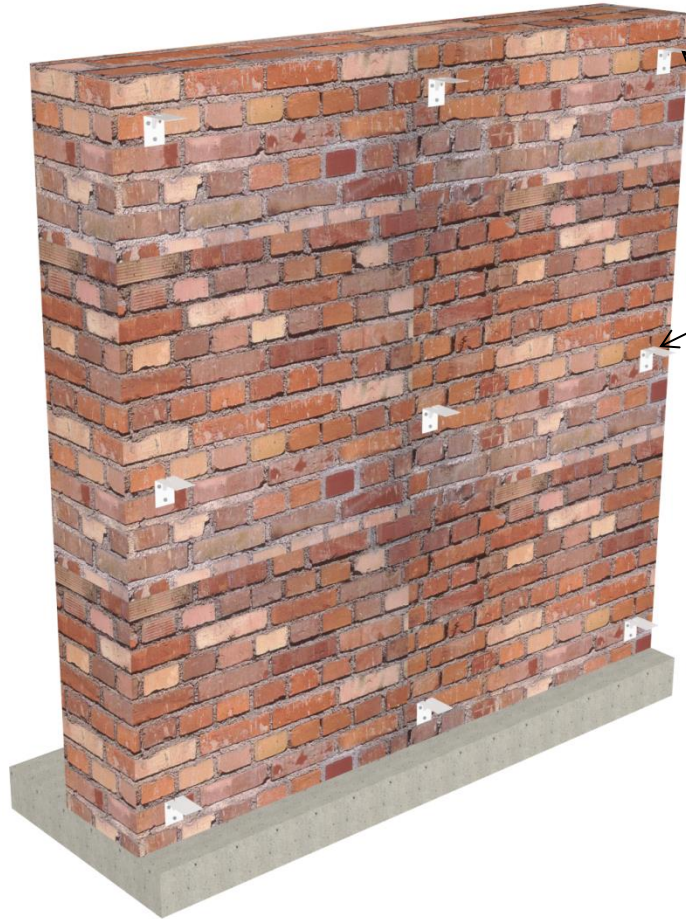

сетка 1200 x 1200

Сечение зависит от:

- **толщины утепления фасада**
- **веса выбранного материала облицовки**

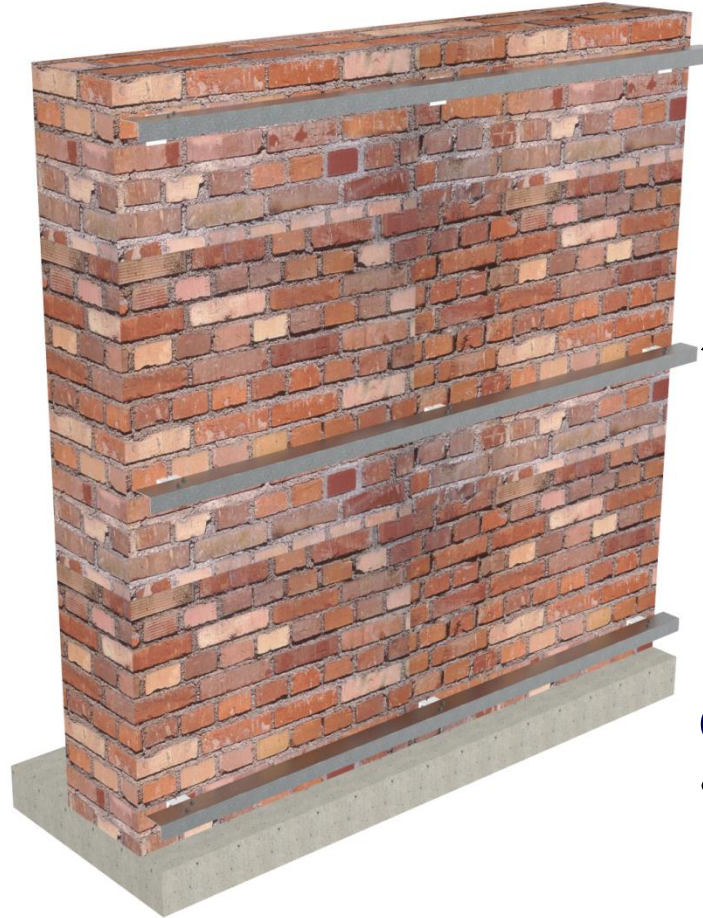

L-прогоны

Сечение зависит от:

- **кривизны выравниваемого фасада**

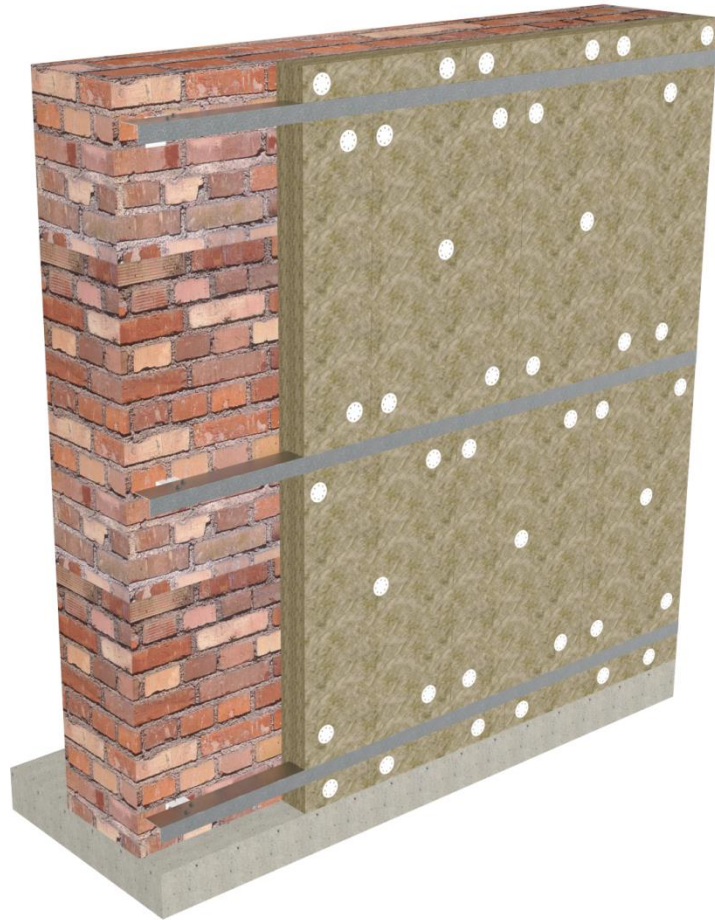

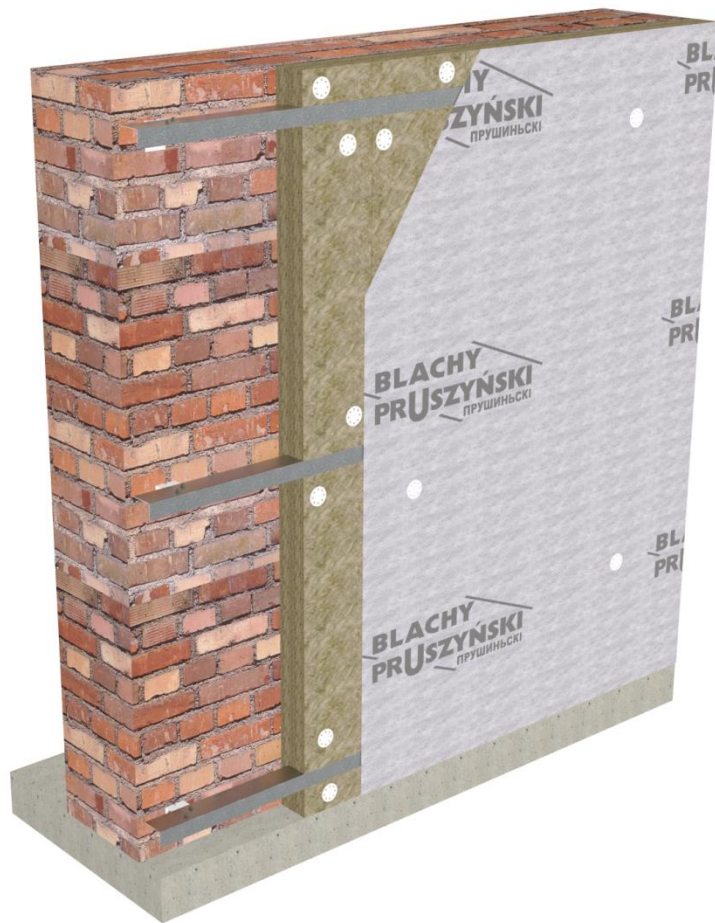

ветрозащитная пленка

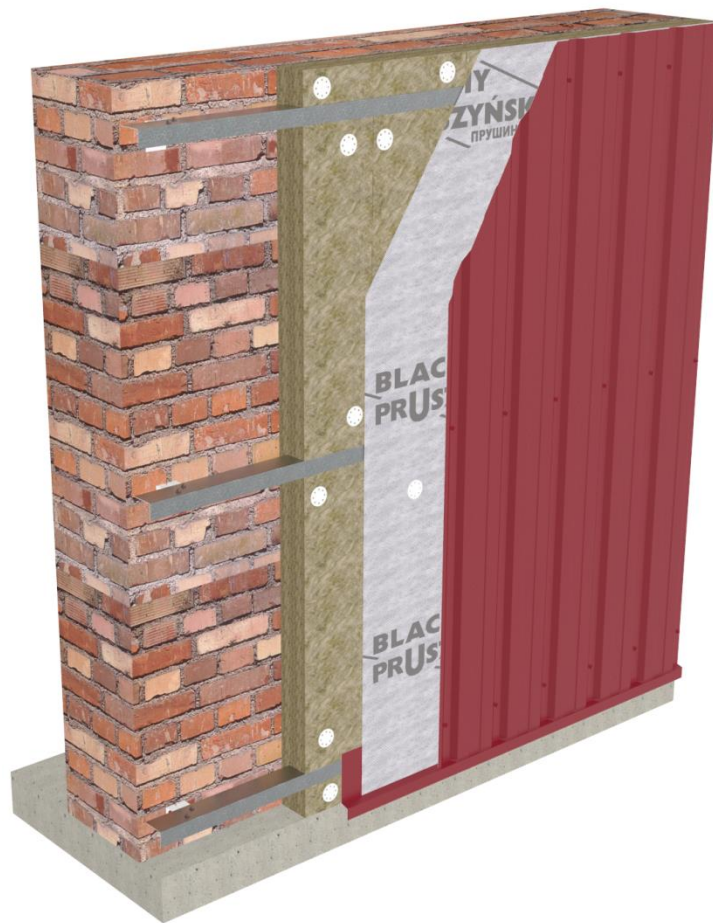

фасадный профнастил

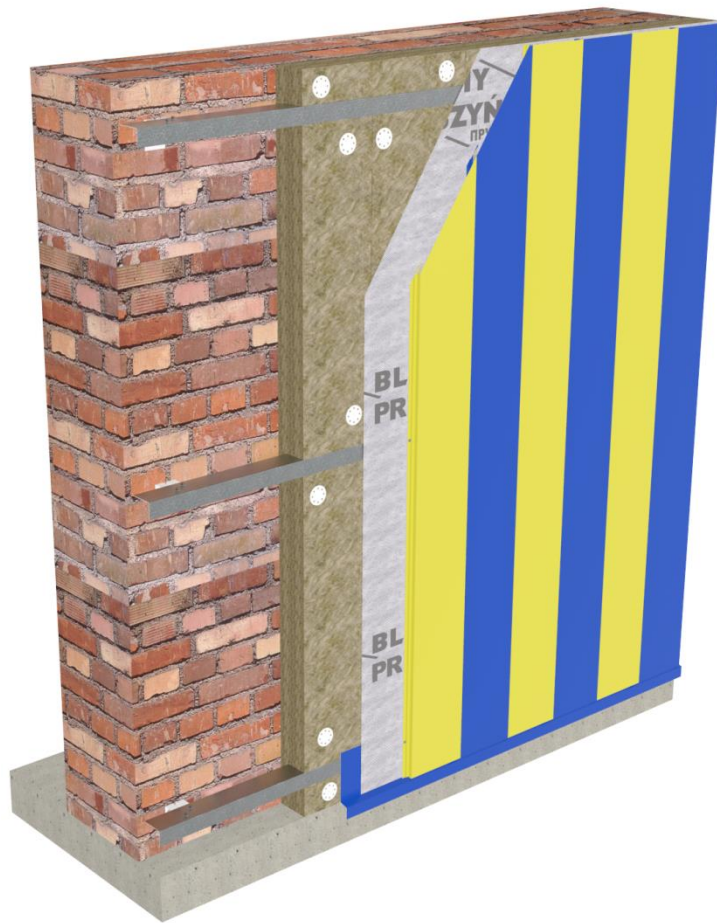

PS-панели вертикально

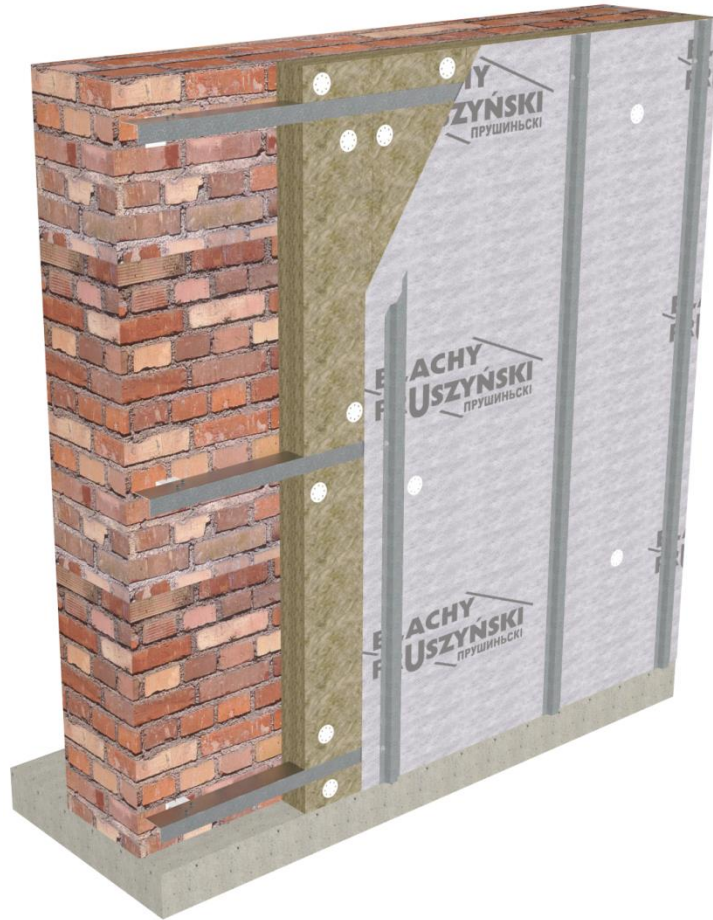

Ω-прогон

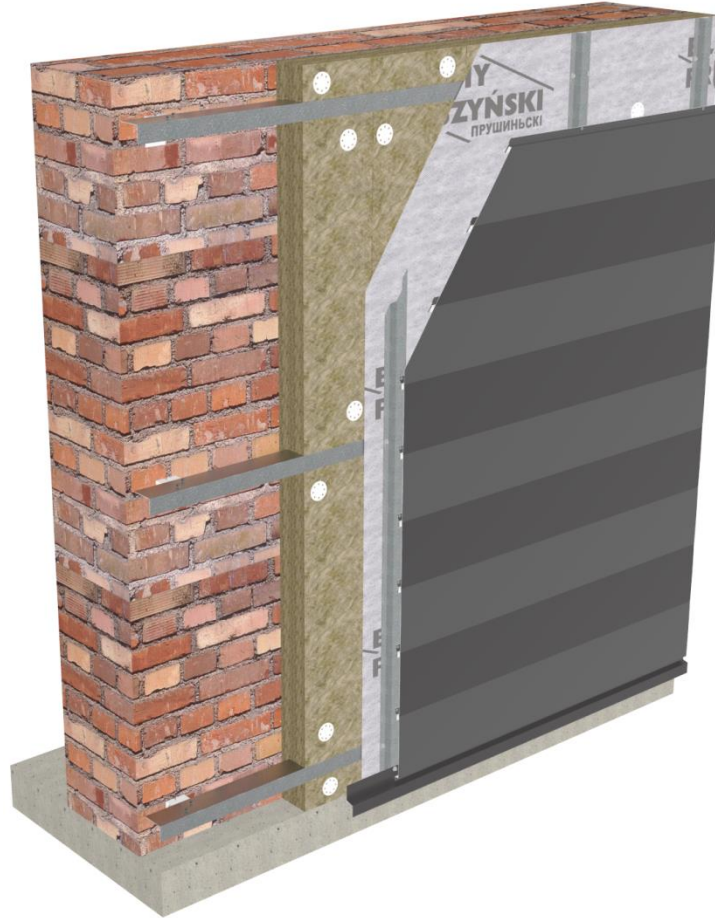

PS-панели горизонтально

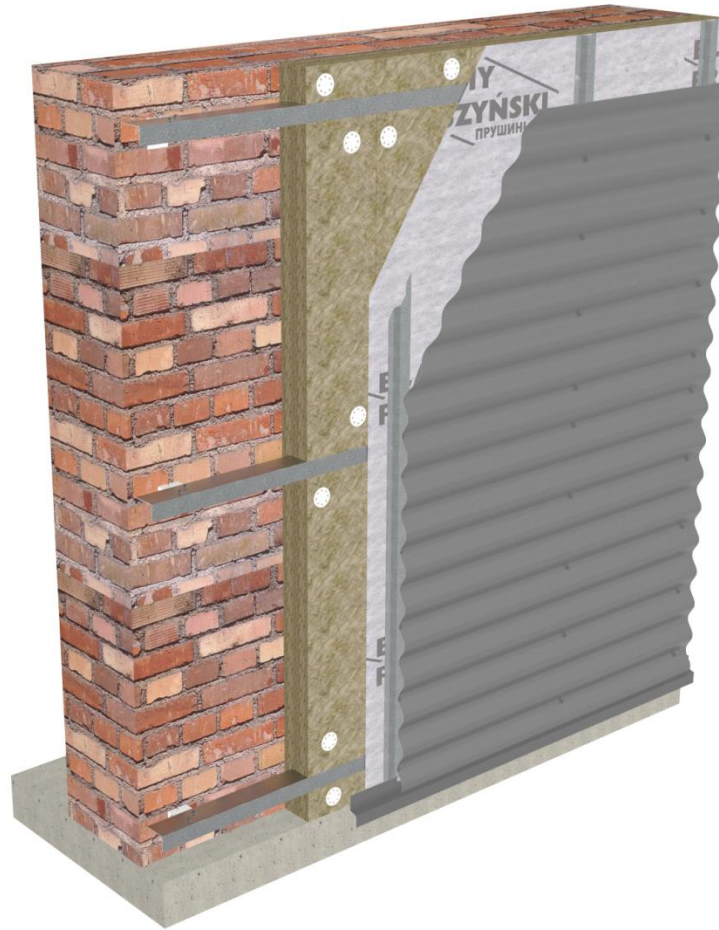

профнастил
горизонтально

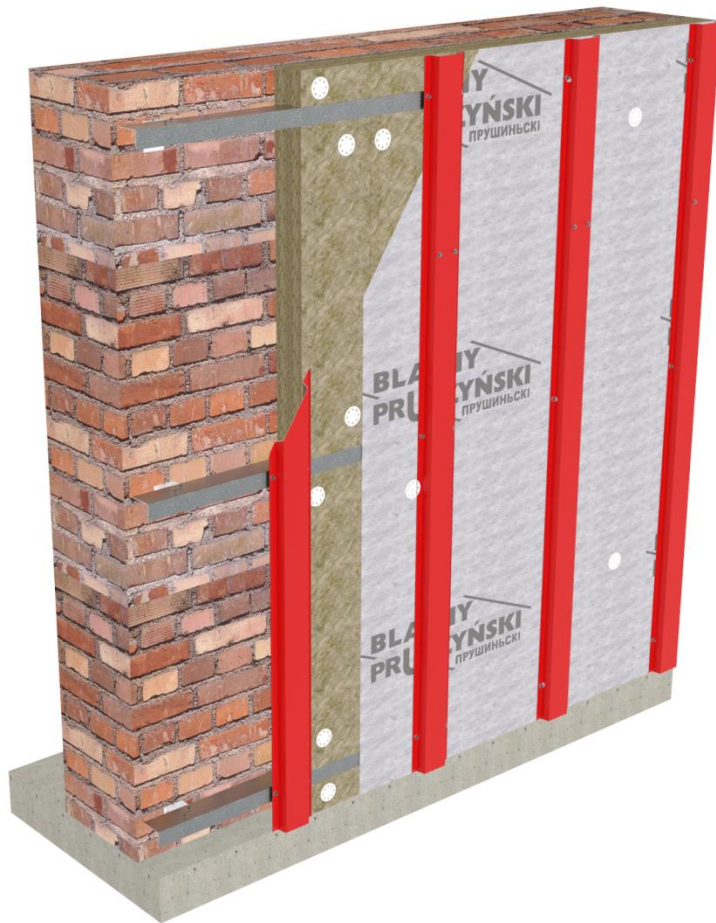



Фасадные кассеты













































Спасибо за внимание!